

















Parts

ITEM	PARTS #	QTY	DESCRIPTION		ITEM	PARTS #	QTY	DESCRIPTION	
A		1	Sliding Panel		I	S-808-D	2	Door Stop	
B		1	Stationary Panel		J	S-808-I	2	Wall Mount Bracket	
C	SDCD38	1	U-Channel		K	5163-K	1	Finger Pull (*Upgrade)	
D	----	2	Bar Mount Bracket		L	LH6X6	1	6" Ladder Pull	
E	S-806-A	1	Support Bar		M	FPG	1	Fixed Panel Guide	
F	----	2	Glass Panel Bracket (Open)		N	SDT980	1	Threshold (Optional)	
G	S-808-E	2	70mm Roller		O	VM-49	1	Door Edge Vinyl	
H	S-808-C	2	Roller Guide		P	VM-50	1	Door Gap Vinyl (Optional)	

Tools



Center Point



#2 Philips Screwdriver



4' and 6' Levels



1/8" and 3/16" Drill Bit



Drill

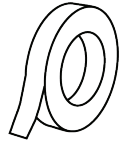

Low Tack Tape
(Masking Tape)



Straight Edge



Tape Measure



Clear 100% Silicone



Mallet

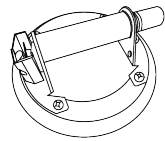

Suction Cups

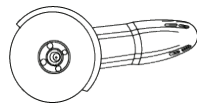

Chop or Grinder Saw



Safety Glasses

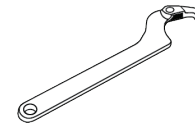

Spanner Wrench

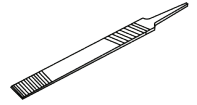

Files

Installation Notes

- Sliding panel goes inside on the shower head side.
- At a minimum 2 x 4 wood blocking is required at the location of all structural parts prior to installation.
- Cover the drain prior to installation to prevent loss of small parts.
- Unpack your unit carefully and inspect for damage. Lay out and identify all parts using and above diagram and parts list.
- Due to the weight, size and complexity of this unit it is best installed by two people.
- Please wear safety glasses whenever drilling or cutting.
- To assure a long lasting finish on the enclosure, wipe it down with a towel (or squeegee) after each use.
- During regular cleaning be sure to avoid harsh chemicals like bleach, ammonia and abrasive cleaners that can damage both the glass and metal.



Caution: Tempered glass cannot be cut or drilled

1.

INSTALLING U-CHANNEL

Step 1a.

- Determine which side the fixed panel will be located. It is recommended that fixed panel is on the opposite side of shower head.
- Measure length of panel (B) and cut u-channel (C) 3/4" shorter than panel length.
- Locate and mark the curb centerline (curb width divided by 2). Place centerline of u-channel (C) out 3/4" from the curb centerline. Using two-sided tape, apply the u-channel to the curb.

1a

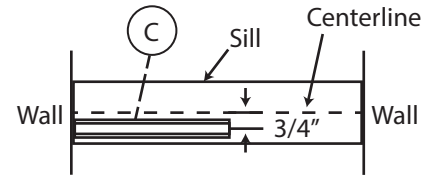

2.

SETTING MOUNTS

Step 2a.

- Determine the inside side of the panel. Then take the two vertical wall mount brackets (J) and attach the glass panel to wall.
- Attach open bar brackets (F) through the holes at the top of stationary panel (B). The bracket holder will face inside of shower. You do not have to fully tighten brackets at this point.
- Put wall mount bracket (J) through the two holes on the vertical edge of glass. Bracket should be on inside of shower.

2a

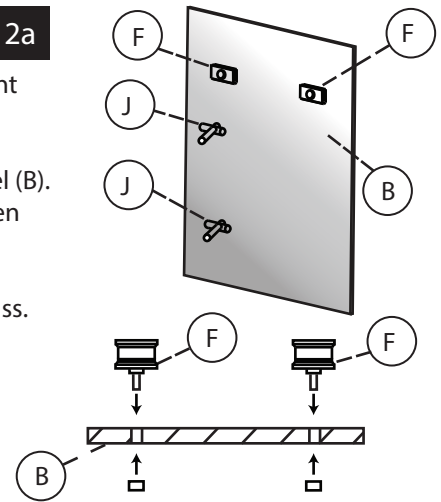

3.

MEASURING SUPPORT BAR

Step 3a.

- Measure shower width 3" below the overall door panel height.
- Using a chop saw or grinder saw (with stainless steel cutting wheel) cut the bar 1-1/8" shorter than the shower width. Most bars are cut at factory.

3a

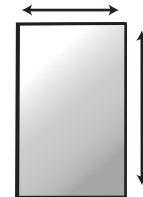

4.

ATTACHING HARDWARE and STATIONARY PANEL to BAR

Step 4a.

- Assume panel is on left. Facing the bar, slide two door stops (I) and bar support bracket (D) onto right side of bar (E).
- Slide bar (E) over both open glass brackets (F). Make sure second door stop (I) is after both open brackets (F) before sliding bar.
- Slide bar mount bracket (D) onto end of bar.

4a

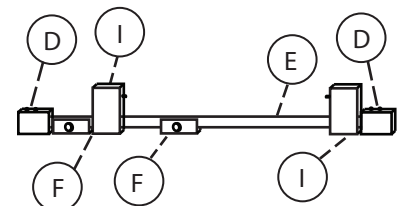

5.

PANEL and BAR

Step 5a.

- Place the stationary panel in bottom u-channel (C) and position bar brackets.
- With panel and bar in place, use a level to level bar from wall to wall.

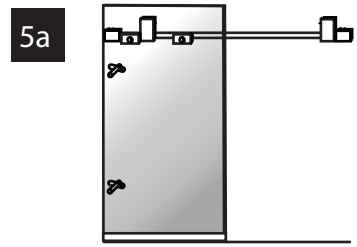

Step 5b.

- Push both end brackets (D) against wall and use a pencil to mark around brackets.
- Next take wall mount panel brackets (J) on stationary panel (B) and use a pencil to mark on wall around bracket. Make sure panel is plumb before marking.

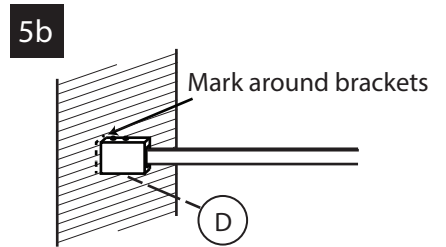

6.

SECURING MOUNT BRACKETS

Step 6a.

- Take bar mount bracket (D) and disassemble so inside mount is loose.
- Take mount and center in hole that was traced on wall. Mark center mount of bracket.
- Drill hole using 3/16" drill bit. To fasten mount brackets, use anchors when wood blocking is not available.

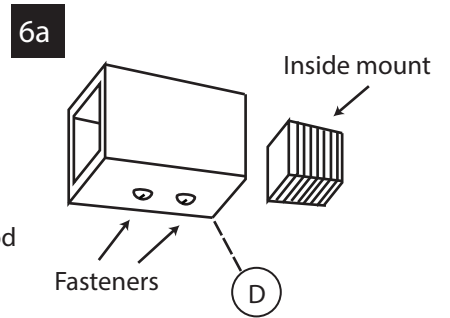

7.

INSERTING WALL MOUNT BRACKETS

Step 7a.

- Take wall mount brackets (J) and disassemble mount.
- Take mount and center on penciled hole. Mark center of hole and drill hole using 3/16" drill bit. Fasten mount to wall.
- Attach threaded glass bracket and thread (spin) the bracket to the mount until tight and align with glass panel holes. Bracket can be adjusted in or out.

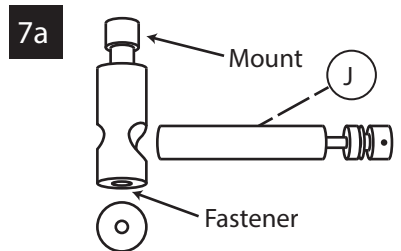

8.

SET PANEL and FASTEN to WALL

Step 8a.

- Slide bar mount brackets (D) onto each end of bar.
- With bar attached to glass, lift glass into u-channel (C).
- Slide both bar brackets (D) onto their mounts on wall. Align allen heads on bottom of bracket. Tighten bar bracket fasteners (D) with allen wrench.

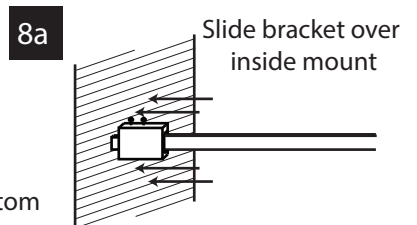

8.

SET PANEL and FASTEN to WALL CONTINUED

Step 8b.

- Fasten wall mount bracket (J) with threaded fastener through glass. Tighten the bracket post in place with flathead screw driver and cover the screw with thread cover.

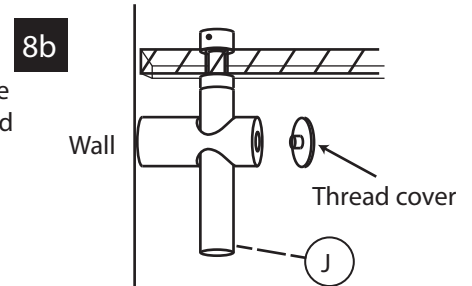

9.

ATTACHING HANDLE and ROLLERS

Step 9a.

- Attach the ladder pull (L) (or finger pull) to door (A) using the allen wrench provided. Or disassemble the optional finger pull (K) by spinning the sides in opposite directions and attach to door by threading each side through the glass.

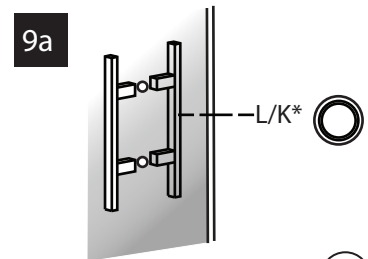

Step 9b.

- Attach the rollers in top holes of the glass with the roller facing the outside of panel.

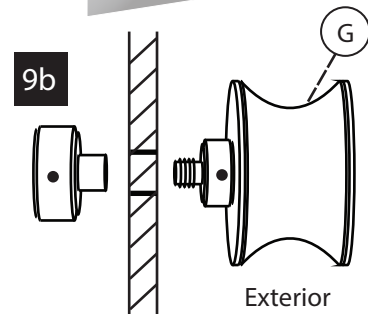

10.

PLACING SLIDING DOOR

Step 10a.

- Prep the curb with shims (5/16") and carefully lower the door rollers onto the center of the bar.

Note: Rollers are a cam design and allow 1/4" adjustment.

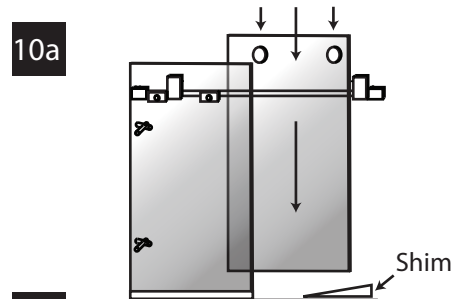

Step 10b.

- With spanner wrench or pin rod, adjust rollers (G) down until they contact the bar. Next unscrew the face plate on front of roller.
- Hold roller (G) in place using allen wrench in front of roller and spanner wrench or pin rod in back. Tighten the fastener in place by turning the allen wrench.
- Replace face plate on front of roller and remove shims so glass panel will be free to roll.

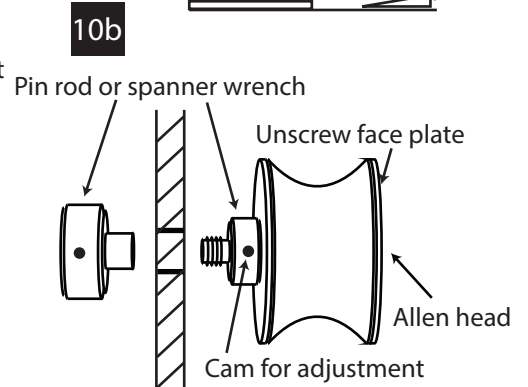

11.

POSITION and FASTEN DOOR STOP

Step 11a.

- Slide the door stops (J) to their effective positions on the bar so that the door edges are protected from damage. Tighten them in place with allen wrench.

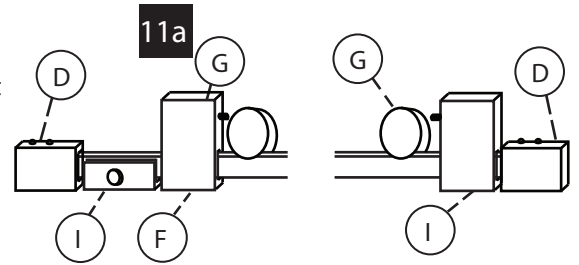

12.

APPLYING DOOR GUIDE

Step 12a.

- Push center guide (M) on the stationary panel and position it so it is straight aligned to the stationary panel and the sill.
- Mark and drill the holes, then secure center guide (M) to sill and to stationary panel (B). Next align panel (A) so that it fits in the other half of center guide (M).

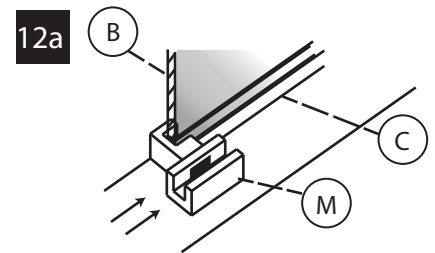

13.

SETTING ROLLER GUIDES

Step 13a.

- Unscrew roller guides (H) and fasten them through the holes below the bar and roller.

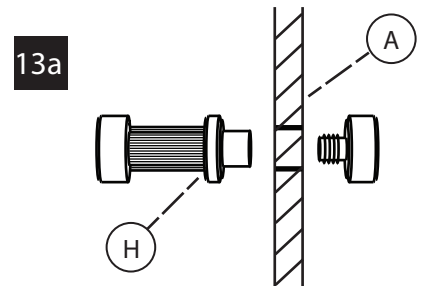

14.

TRIM DOOR EDGE VINYL

Step 14a.

- Push door edge vinyl (O) onto slider glass (A) so when the door closes it seals against the wall. Trim excess from the top of the glass.

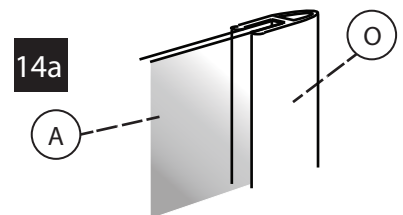

15.

VINYL GAP SEAL and SILICONE

Step 15a.

- OPTIONAL- With door gap vinyl (P) seal faced inside, push it on to the glass and trim the excess below the bar.
- OPTIONAL- If sill is level and for extra water protection, a semi round damstrip (N) is provided. Line up damstrip inline with fixed glass panel (B).
- Silicone u-channel to base and glass both outside and inside.

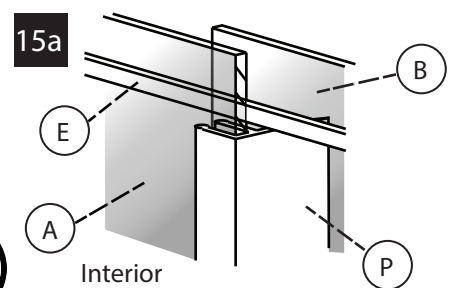

24hrs